

STM32

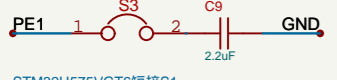

SPI FLASH

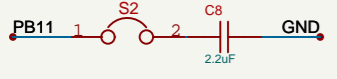
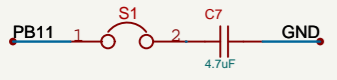
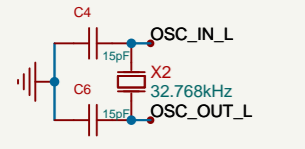
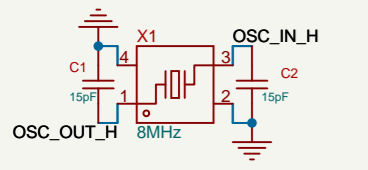
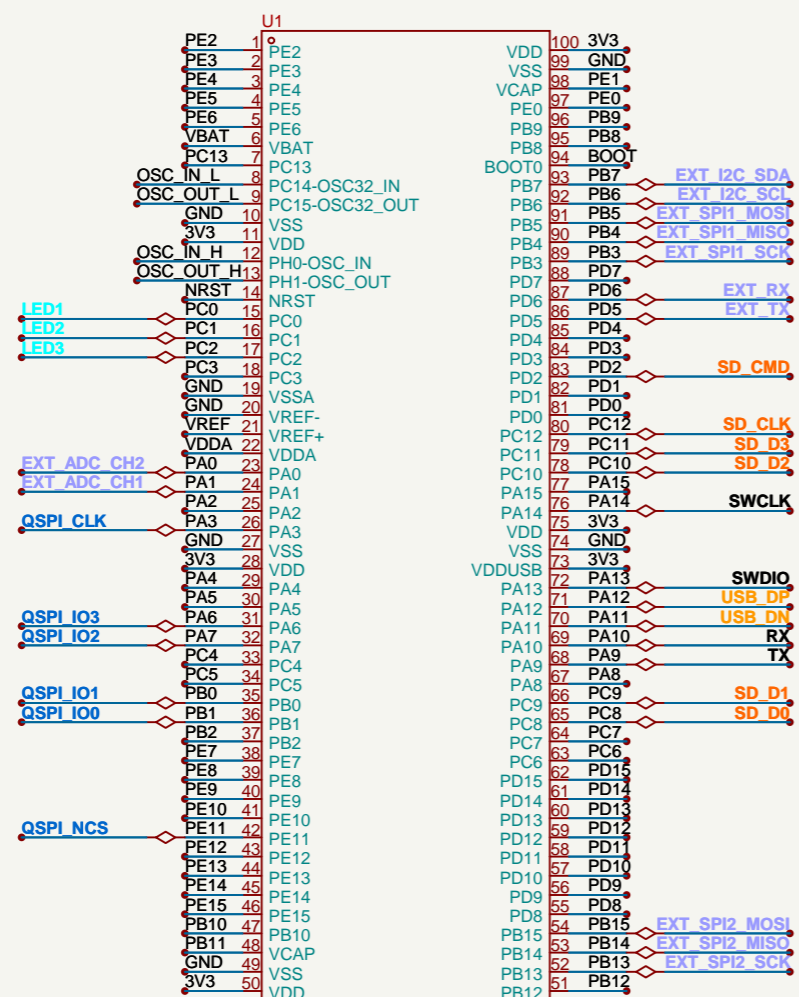
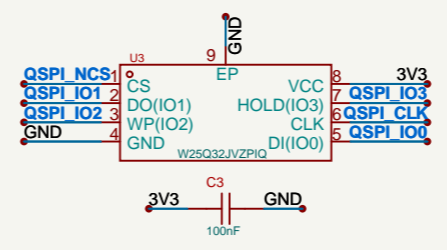

TF卡座

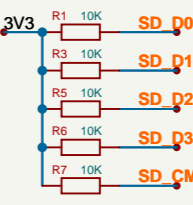
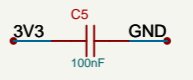
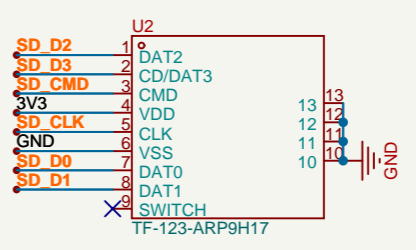

USB

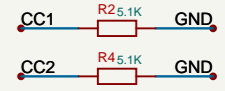
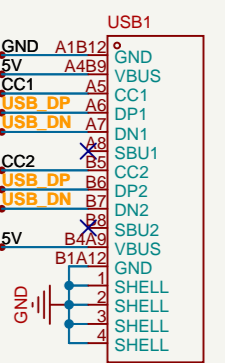

RTC供电

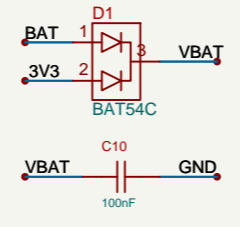

IO接口

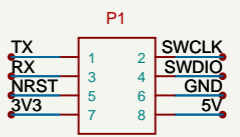

系统供电

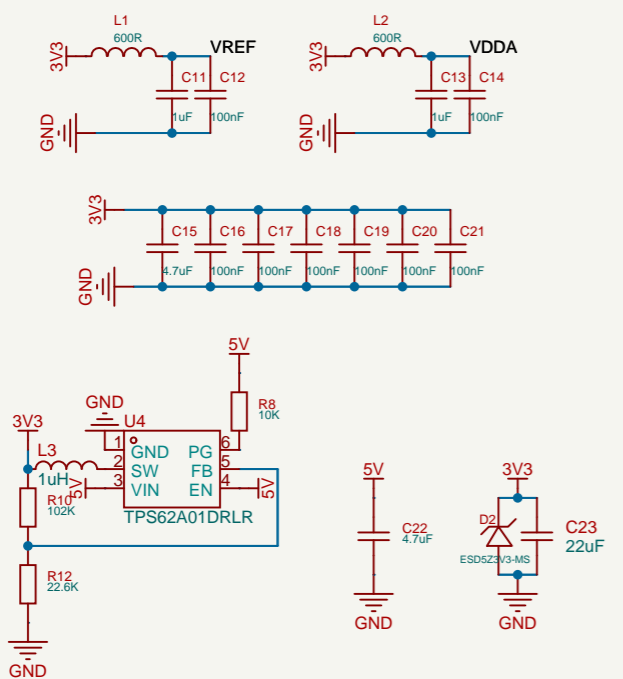

LED & 按键

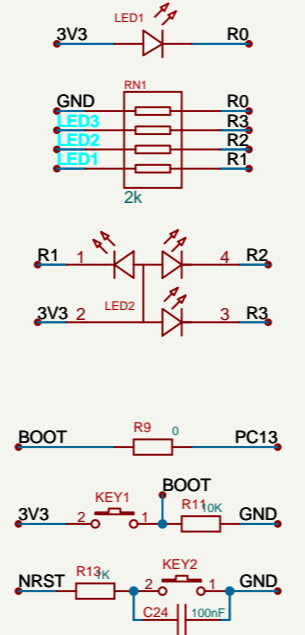

FPC扩展口

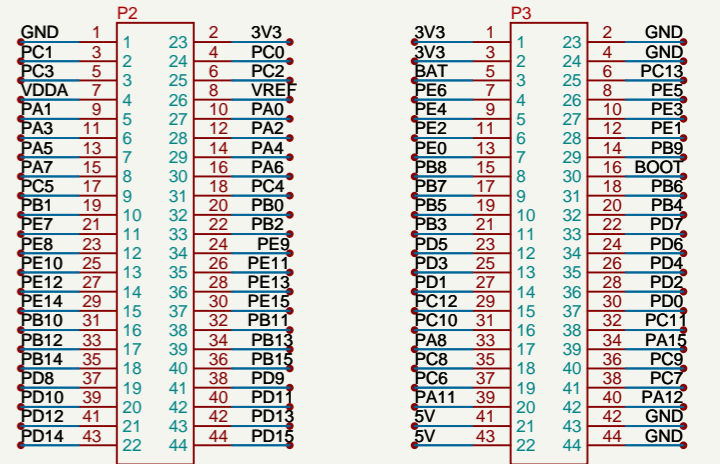
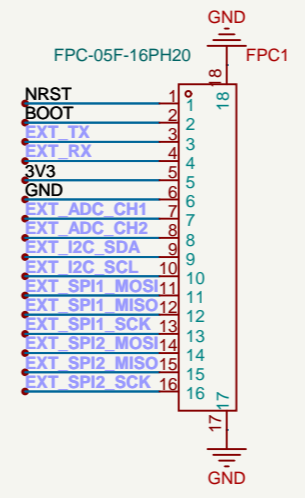

X Pulse 原理图
 型号：STM32U575VGT6
 版本：v1.0